

Advies
Gebruik RVS schroeven 4,0 x 40 mm die goedgekeurd zijn door SKH.

De nastelbare sluitkom kan voor zowel de bovenste, als de onderste haakschoot gebruikt worden.

LET OP: Maten controleren in het werk!

T-Beitel
Art. nr. 406504

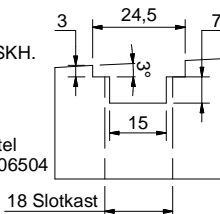

Treatment	Units	MM	Roughness	Unspecified tolerances	According NEN-ISO 1101
Aftertreatment	Not on scale bases	25	3.2	Dim ± 0.2 Angle ± 0.5°	
Layer thickness	Reference	(25)	Scale	Engineer: B. Pongers	Checked by: R. Bourmans
Description: HMB MPS Cilinderbediend Serie 001 VPL 1950 DM 55			Projection	Date: 25-7-2013	Date: 22-04-2014
HMB profit locks & tools <small>Postbus 151 3400 AD IJSELSTEIN, HOLLAND TELEPHONE: 0031 - (0)30 - 6877940 FAX: 0031 - (0)30 - 6875688 E-MAIL: info@hmb.nl</small>			Scale	Revision	Artikel number:
			A2	00	500270
			Projection	Sheetsize	Drawing number
				A2	400.500270

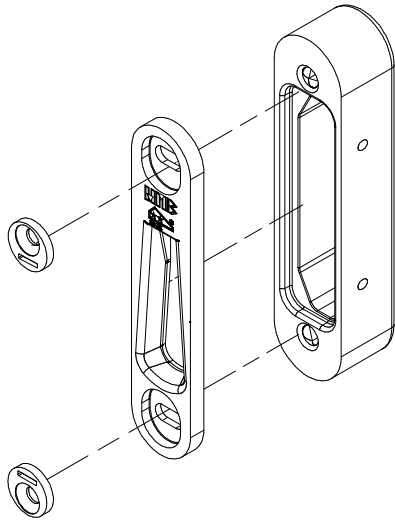

Nastelbare
Sluitkom en Sluitplaat
tbv Haakschoot
Art. nr. 706300

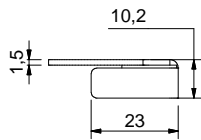
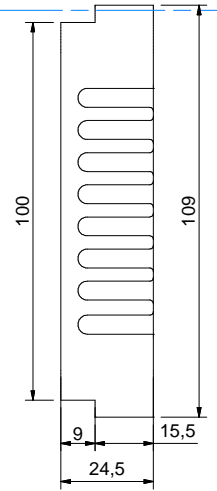
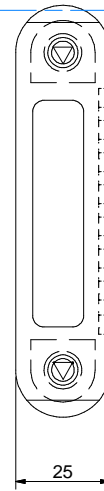
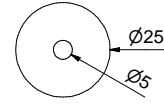
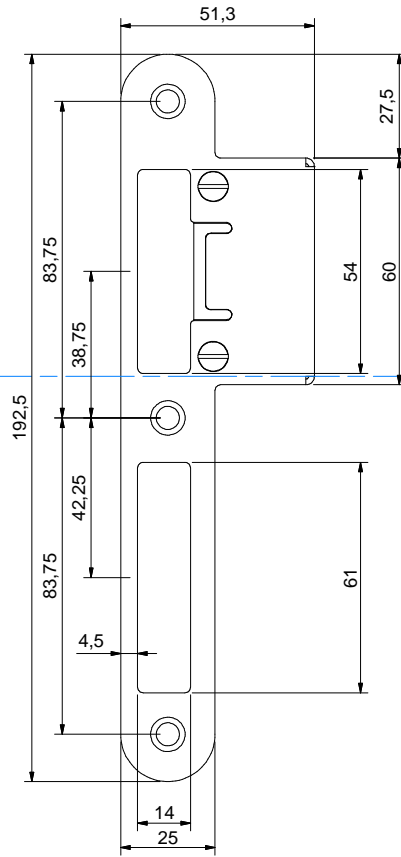
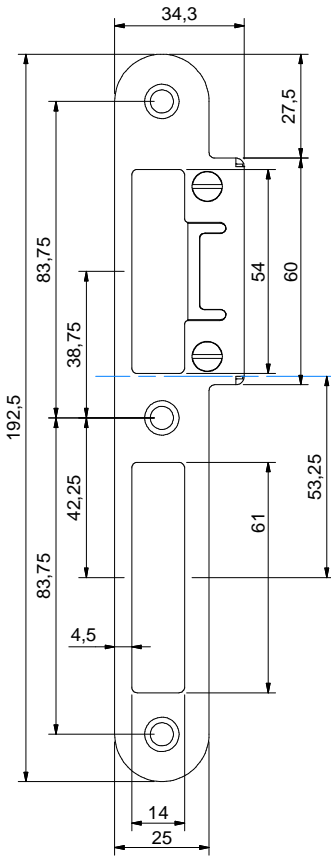
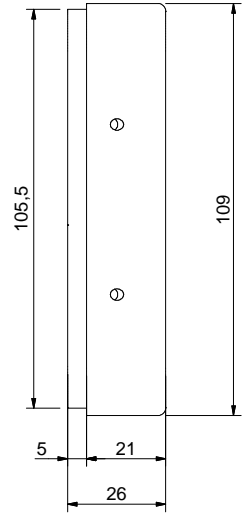
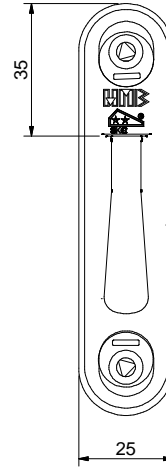

Verstelbare Sluitplaat
Korte Lip
Art. nr. 706380 (DIN Links)
Art. nr. 706390 (DIN Rechts)

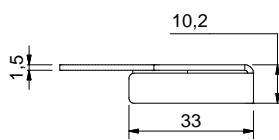

Verstelbare Sluitplaat
Lange Lip
Art. nr. 706400 (DIN Links)
Art. nr. 706410 (DIN Rechts)

Opvulling
Art. nr. 700006
Sluitkom
Art. nr. 707022