

**Advies**  
Gebruik RVS schroeven 4,0 x 40 mm die goedgekeurd zijn door SKH.

De nastelbare sluitkom kan voor zowel de bovenste, als de onderste haakschoot gebruikt worden.

**LET OP: Maten controleren in het werk!**

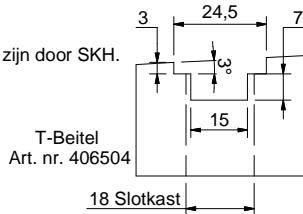

Aftertreatment	Treatment	Units	MM	Roughness	Unspecified tolerances	According NEN-ISO 1101
Layer thickness	Reference	Not on scale bases	25	3.2	Dim ± 0.2 Angle ± 0.5°	
Description: HMB MPS Cilinderbediend Serie 004 VPL 1700 DM 65				Scale	Engineer: B. Pongers	Checked by: R. Boumans
HMB® profit locks & tools				Projection	Revision: 00	Antikel number: 500292
Postbus 151 3400 AD IJSELSTEIN, HOLLAND TELEPHONE: 0031 - (0)30 - 6877940 FAX: 0031 - (0)30 - 6875688 E-MAIL: info@hmb.nl				Scale: A2	Date: 23-7-2013	Date: 22-04-2014
THIS DRAWING REMAINS PROPERTY OF HMB PROFIT LOCKS & TOOLS AND MAY NOT BE COPIED WITHOUT OUR WRITTEN CONSENT.					Drawing number: 400.500292	

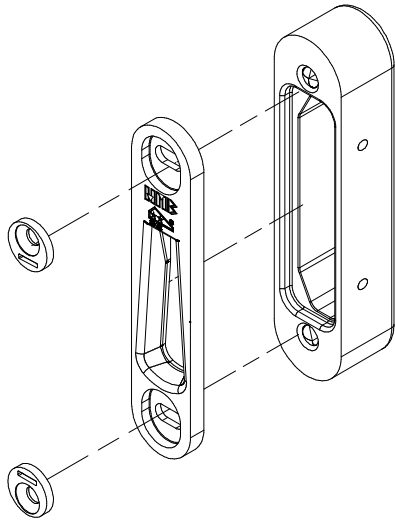

Nastelbare  
Sluitkom en Sluitplaat  
tbv Haakschoot  
Art. nr. 706300

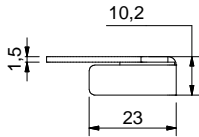
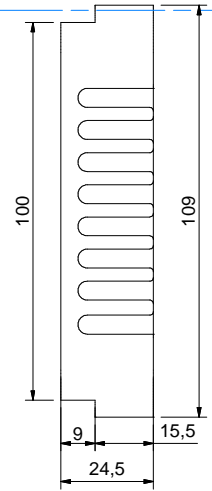
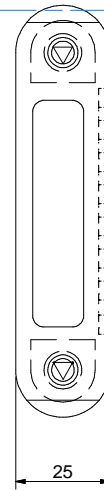
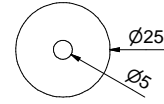
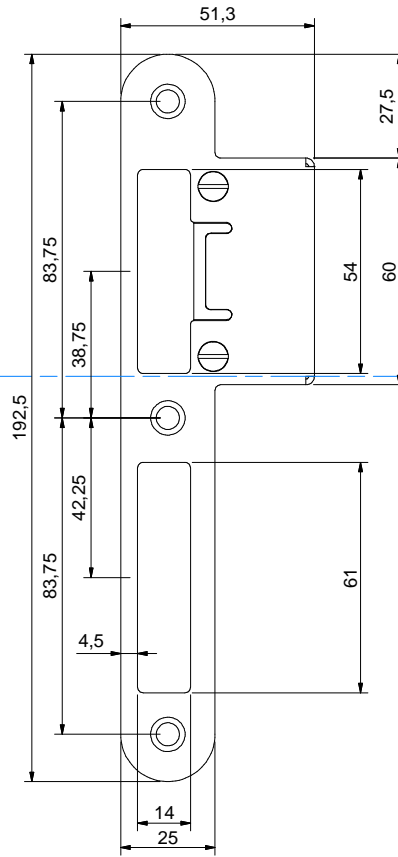
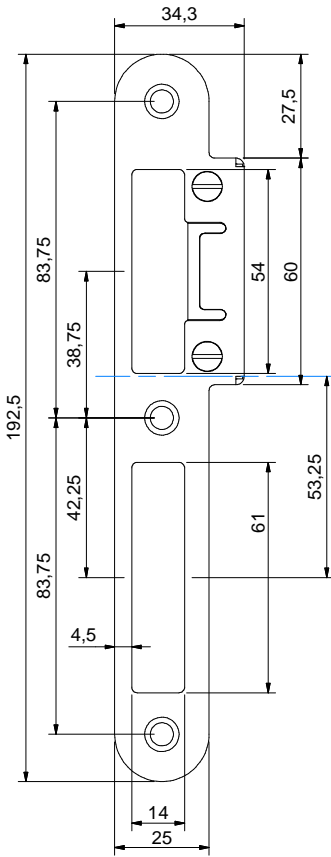
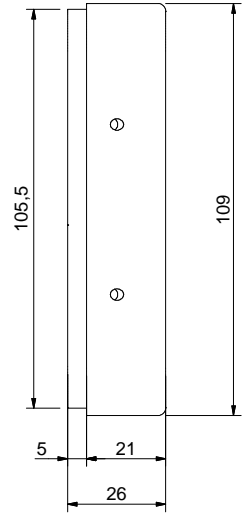
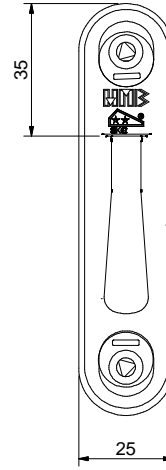

Verstelbare Sluitplaat  
Korte Lip  
Art. nr. 706380 (DIN Links)  
Art. nr. 706390 (DIN Rechts)

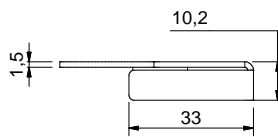

Verstelbare Sluitplaat  
Lange Lip  
Art. nr. 706400 (DIN Links)  
Art. nr. 706410 (DIN Rechts)

Opvulling  
Art. nr. 700006  
Sluitkom  
Art. nr. 707022